

1	2	3	4	5	6	7	8	9	10
A	APPARATSKÅP SEE COOLING (EBMPAPST)								
B	INNEHÅLLSFÖRTECKNING 1								
C	APPARATPLACERING 2								
	APPARATLISTA 3								
	HUVUDKRETSSCHEMA 4								
	MANÖVERKRETSSCHEMA 5 - 7								
	YTTRE ANSLUTNINGSSCHEMA 8 - 11								



AVS
ELKRAFT & AUTOMATION
TEL +46(0) 472 162 00
WWW.AVS-AB.COM



AIA
Cooling Your Daily Life®
Member of LU-VE GROUP

LU-VE SWEDEN AB
TEL +46(0) 454 334 00
WWW.AIA.SE

31042252
HDZ2-6-33-42-X/P-R30-2W
SEE COOLER
INNEHÅLLSFÖRTECKNING

ARBETSNUMMER
KONSTRUERAD AV
MKW
DATUM
2021-09-27

RITTINGSNUMMER
614-7143904
RITAD AV
MKW
REV.
FORTS.
2

REV.	ÄNDRING	SIGN.	DATUM
------	---------	-------	-------

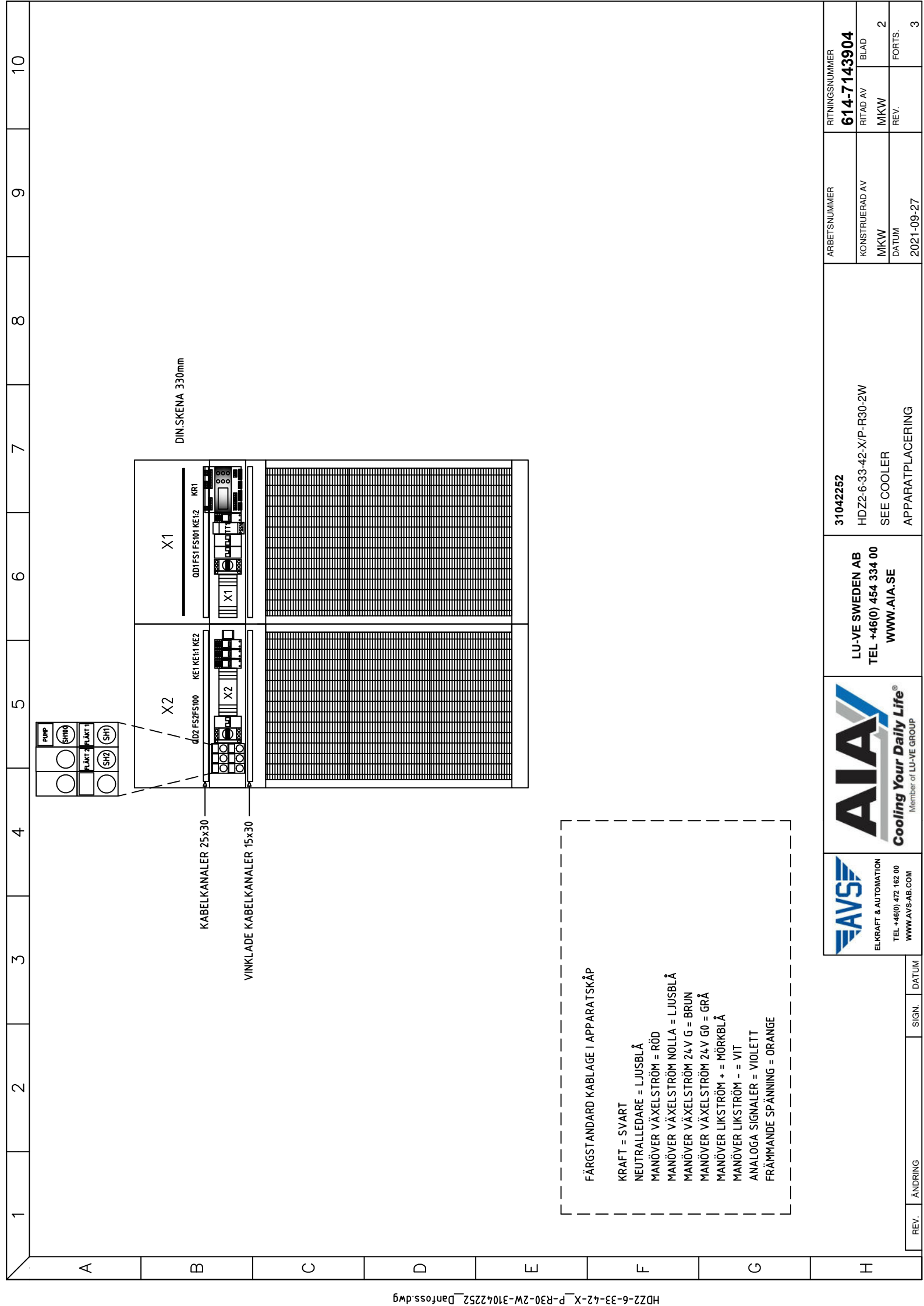

FÄRGSTANDARD KABLAGE I APPARATSKÅP

KRAFT = SVART
 NEUTRALLEDARE = LJUSBLÅ
 MANÖVER VÄXELSTRÖM = RÖD
 MANÖVER VÄXELSTRÖM NOLLA = LJUSBLÅ
 MANÖVER VÄXELSTRÖM 24V G = BRUN
 MANÖVER VÄXELSTRÖM 24V G0 = GRÅ
 MANÖVER LIKSSTRÖM + = MÖRKBLÅ
 MANÖVER LIKSSTRÖM - = VIT
 ANALOGA SIGNALER = VIOLETT
 FRÄMMANDE SPÄNNING = ORANGE

RITINGSNUMMER 614-7143904	ARBETSNUMMER	31042252	LU-VE SWEDEN AB TEL +46(0) 454 334 00 WWW.AIA.SE	 Cooling Your Daily Life® Member of LU-VE GROUP	 ELKRAFT & AUTOMATION TEL +46(0) 472 162 00 WWW.AVS-AB.COM	REV.	ÄNDRING	SIGN.	DATUM
	RITAD AV MKW					KONSTRUERAD AV MKW	SEE COOLER	WWW.AIA.SE	WWW.AVS-AB.COM
BLAD 2	DATUM 2021-09-27	APPARATPLACERING							
FORTS. 3									

1	2	3	4	5	6	7	8	9	10
A	POS	ANTAL	NAMN	TILLVERKARE	TYP	DATA	ART-NUMMER	ANMÄRKNING	
B									
C									
D									
E									
F									
G									
H									

POS	ANTAL	NAMN	TILLVERKARE	TYP	DATA	ART-NUMMER	ANMÄRKNING
	2	MONTERINGSPLÅT	AVS	BAS-PLÅT		602-1009910	
	1	MONTERINGSPLÅT	AVS	PLÅT REGULATOR		602-1009911	
	1	MONTERINGSPLÅT	AVS	PLÅT BRYTARE		602-1009912	
	1	DIN-SKENA	WEIDMULLER	TS 15	330mm	129-2929201	
QD1-QD2	2	HUVUDBRYTARE	SONTHEIMER	HL040/4T/Z208ggr	4-POLER	131-3134270	
FS1-FS2	2	DVÄRGBRYTARE	SCHNEIDER ELECTRIC	A9F07206	iC60H 2P C6A	121-2112149	
FS101	1	DVÄRGBRYTARE	SCHNEIDER ELECTRIC	A9F07206	iC60H 2P C6A	121-2112149	
FS100	1	PLINTSÄKRING	WEIDMULLER	WSI 6	0.5A	129-2919864	
(FS100)	1	ÄNDPLATTA	WEIDMULLER	WAP 2.5-10		129-2919921	
SH1-SH2	2	BRYTARE	SCHNEIDER ELECTRIC	XB4BD33	3-FAST POSITIONER/2NO	137-3732626	
SH1-SH2	2	HJÄLKONTAKT	SCHNEIDER ELECTRIC	ZBE101	NO	137-3733195	
SH1-SH2	2	SKYLTHÅLLARE	SCHNEIDER ELECTRIC	ZBZ33	18X27	137-3733523	
SH100	1	BRYTARE	SCHNEIDER ELECTRIC	XB4BD21	2-FASTA POSITIONER/1NO	137-3732624	
SH100	1	HJÄLPKONTAKT	SCHNEIDER ELECTRIC	ZBE101	NO	137-3733195	
SH100	1	SKYLTHÅLLARE	SCHNEIDER ELECTRIC	ZBZ33	18X27	137-3733523	
KE1-KE1:2	3	RELÄ	SCHNEIDER ELECTRIC	RXM4AB2P7	4-POLER 230VAC	140-4027797	
KE2	1	RELÄ	SCHNEIDER ELECTRIC	RXM4AB2B7	4-POLER 24VAC	140-4027794	
KE1-KE2	4	RELÄ SOCKEL	SCHNEIDER ELECTRIC	RXZE14P	4-POLER	140-4099132	BLADFÄDER
TT1	1	TRANSFORMATOR	TUFVASSONS	PSS10	230/24VAC 10VA	152-5204035	PTC SKYDD
KR1	1	REGULATOR	DANFOSS	MCX08M2	230VAC	145-9945239	
X1	31	PLINT	WEIDMULLER	A3C 1.5	BLADFÄDER	129-2919334	
X1	2	JORDPLINT	WEIDMULLER	A3C 2.5PE	BLADFÄDER	129-2919118	
X1	1	ÄNDPLATTA	WEIDMULLER	AEP 3C2.5		129-2919234	
X2	20	PLINT	WEIDMULLER	A3C 2.5	BLADFÄDER	129-2919113	
X2	2	JORDPLINT	WEIDMULLER	A3C 2.5PE	BLADFÄDER	129-2919118	
X2	2	ÄNDPLATTA	WEIDMULLER	AEP 3C 2.5		129-2919234	
X1/X2	3	ÄNDSTÖD	WEIDMULLER	ZEW35		129-2919930	
W	36	KABELMÄRKNING	WEIDMULLER	1852360000	GUL	614-714-0000	
	2	EMBALLAGE	HELMER NILSSON	WELLOMSLAG 04.09		380-0000094	

ARBETSNUMMER	31042252	RITTINGSNUMMER	614-7143904
KONSTRUERAD AV	LU-VE SWEDEN AB	RITAD AV	BLAD
MKW	TEL +46(0) 454 334 00	MKW	3
DATUM	WWW.AIA.SE	REV.	FORTS.
2021-09-27			4
APPARATLISTA			

AVS	AIA
ELKRAFT & AUTOMATION	Cooling Your Daily Life®
TEL +46(0) 472 162 00	Member of LU-VE GROUP
WWW.AVS-AB.COM	

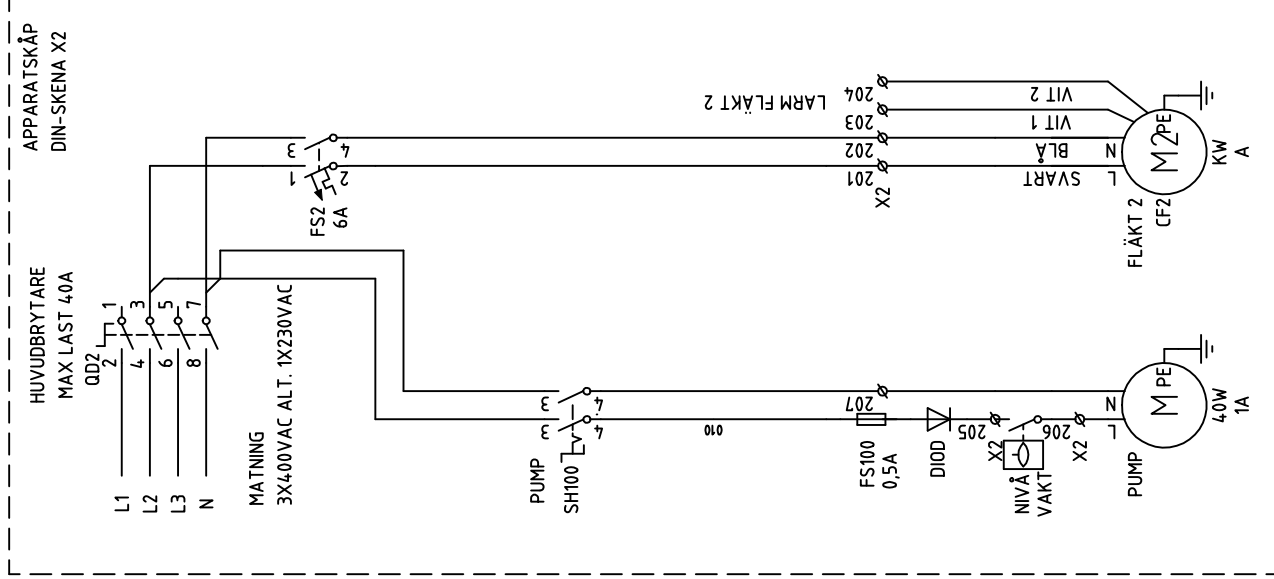
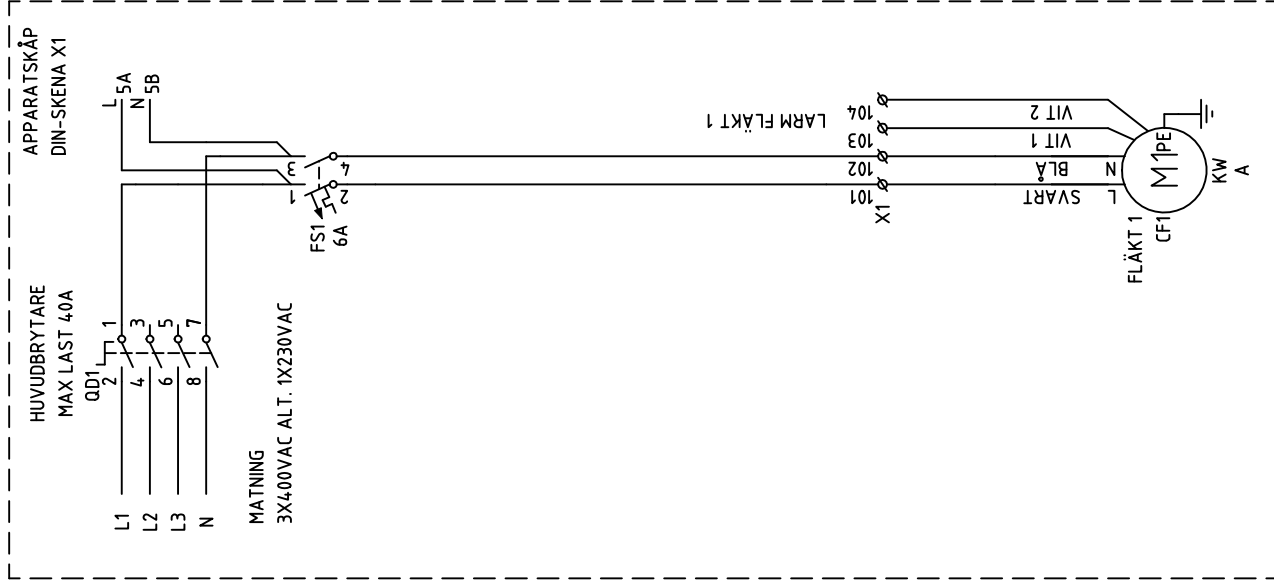

ELKRAFT & AUTOMATION
 TEL +46(0) 472 162 00
 WWW.AVS-AB.COM



Cooling Your Daily Life®
 Member of LU-VE GROUP

LU-VE SWEDEN AB
 TEL +46(0) 454 334 00
 WWW.AIA.SE

31042252
 HDZ2-6-33-42-X/P-R30-2W
 SEE COOLER
 HUVUDKRETSSCHEMA

ARBETSNUMMER	RITINGSNUMMER
KONSTRUERAD AV	614-7143904
MKW	BLAD
DATUM	REV.
2021-09-27	4
	FORTS.
	5

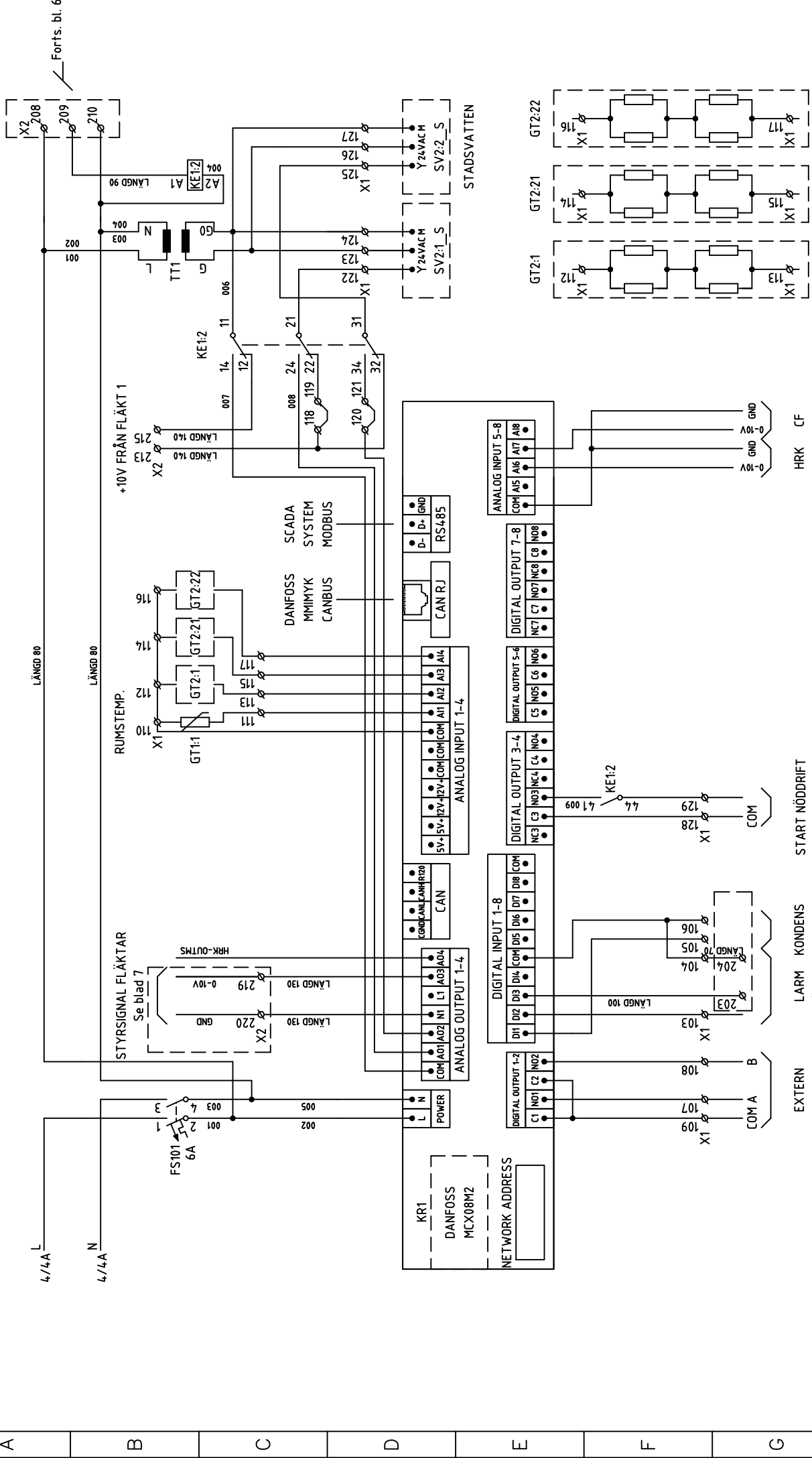

EXTERN LARMSIGNAL	LARM	KONDENS	FLÅKTAR LARM	START NÖDDRIFT MAGNETVENTIL SV3 230VAC ELLER 24V	HRK CF	INEXT													
DIGITAL OUTPUT 1-2	C1	NO1	C2	NO2	DIGITAL INPUT 1-8	DI1	DI2	DI3	DI4	COM	DI6	DI7	DI8	COM					
DIGITAL OUTPUT 3-4	NC3	C3	NO3	NC4	C4	NO4	DIGITAL OUTPUT 5-6	C5	NO5	C6	NO6	DIGITAL OUTPUT 7-8	NC7	C7	NO7	NC8	C8	NO8	
ANALOG INPUT 1-4	AI1	AZ1	AI3	AI4	AI2	AI4	ANALOG INPUT 5-8	COM	AI5	AI6	AI7	AI8	GND	GND	CF	INEXT			
ANALOG OUTPUT 1-4	COM	AO1	AO2	NI	LI	AO3	AO4	COM	D-	D+	GND	RS485	CAN RJ	CAN	COM	LA	MA	NR20	
SCADA SYSTEM MODBUS	DANFOSS MMMYK CANBUS	SCADA SYSTEM MODBUS	RS485	CAN RJ	CAN	COM	LA	MA	NR20	STADSVATTEN	SV2:1 S	Y24VAC M	SV2:2 S	Y24VAC M					
TILLOPPS TEMP.	TEMP.	RETUR TEMP.	TEMP.	RETUR TEMP.	TEMP.	RETUR TEMP.	TEMP.	CF2											
RITINGSNUMMER ARBETSNUMMER KONSTRUERAD AV DATUM 614-7143904 MKW 2021-09-27									RITAD AV REV. MKW 5										
31042252 HDZ2-6-33-42-X/P-R30-2W SEE COOLER MANÖVERKRETSSCHEMA									LU-VE SWEDEN AB TEL +46(0) 454 334 00 WWW.AIA.SE										
AVS ELKRAFT & AUTOMATION TEL +46(0) 472 162 00 WWW.AVS-AB.COM									AIA Cooling Your Daily Life® Member of LU-VE GROUP										
REV.	ÄNDRING	SIGN.	DATUM	2021-09-27 MKW 5								2021-09-27 MKW 5							

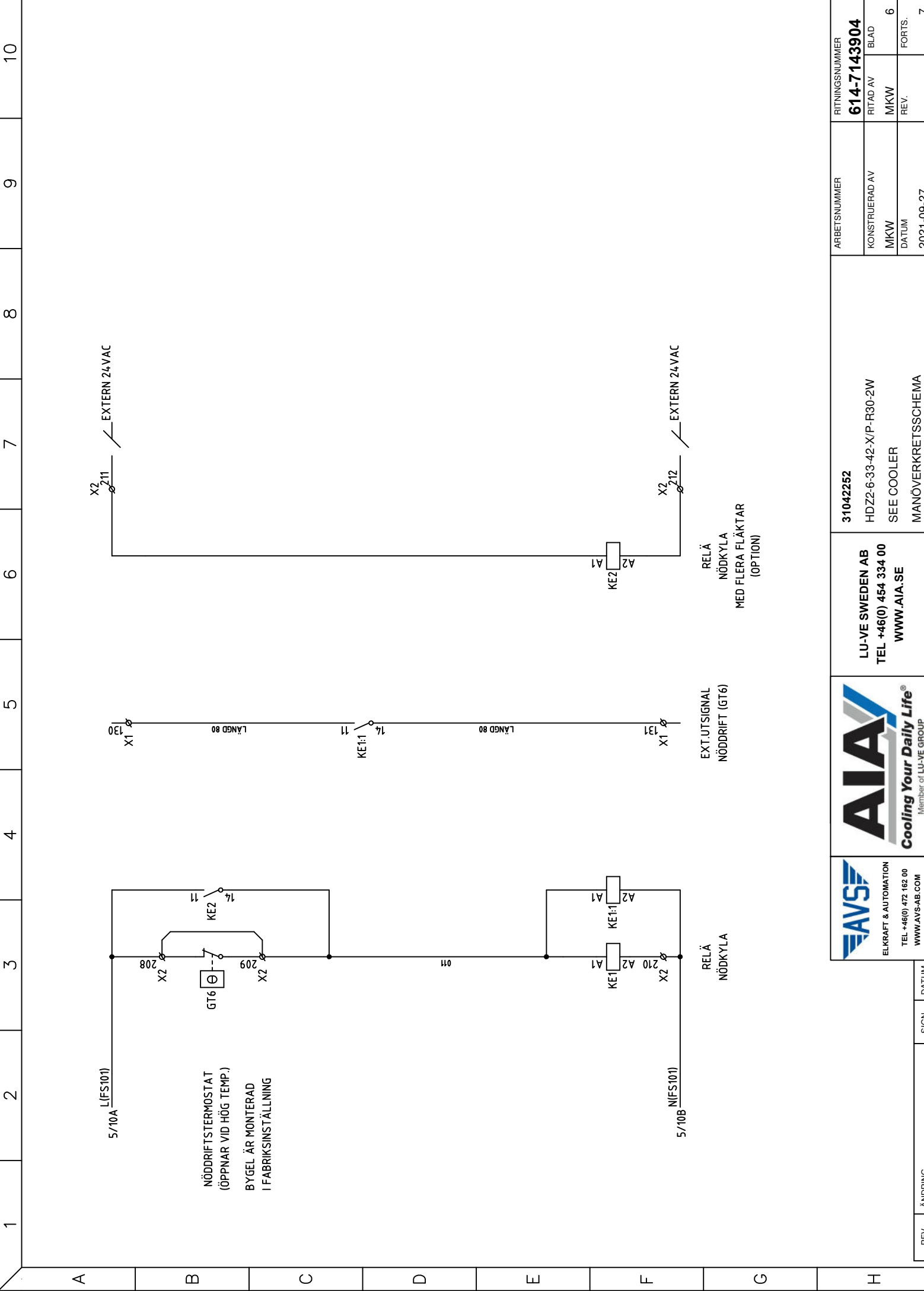

1
2
3
4
5
6
7
8
9
10

A
B
C
D
E
F
G
H

5/10A L(FS101)
NÖDDRIFTSTERMOSTAT
(ÖPPNAR VID HÖG TEMP.)
BYGEL ÄR MONTERAD
I FABRIKSINSTÄLLNING

EXT.UTSIGNAL
NÖDDRIFT (GT6)

RELÄ
NÖDKYLA
MED FLERA FLÄKTAR
(OPTION)

RELÄ
NÖDKYLA

31042252
HDZ2-6-33-42-X/P-R30-2W
SEE COOLER
MÄNÖVERKRETSSCHEMA

LU-VE SWEDEN AB
TEL +46(0) 454 334 00
WWW.AIA.SE

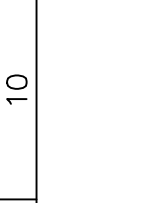
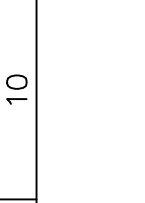

REV.	ÄNDRING	SIGN.	DATUM

ARBETSNUMMER	RITINGSNUMMER
31042252	614-7143904

KONSTRUERAD AV	RITAD AV	BLAD
MKW	MKW	6

DATUM	REV.	FORTS.
2021-09-27		7

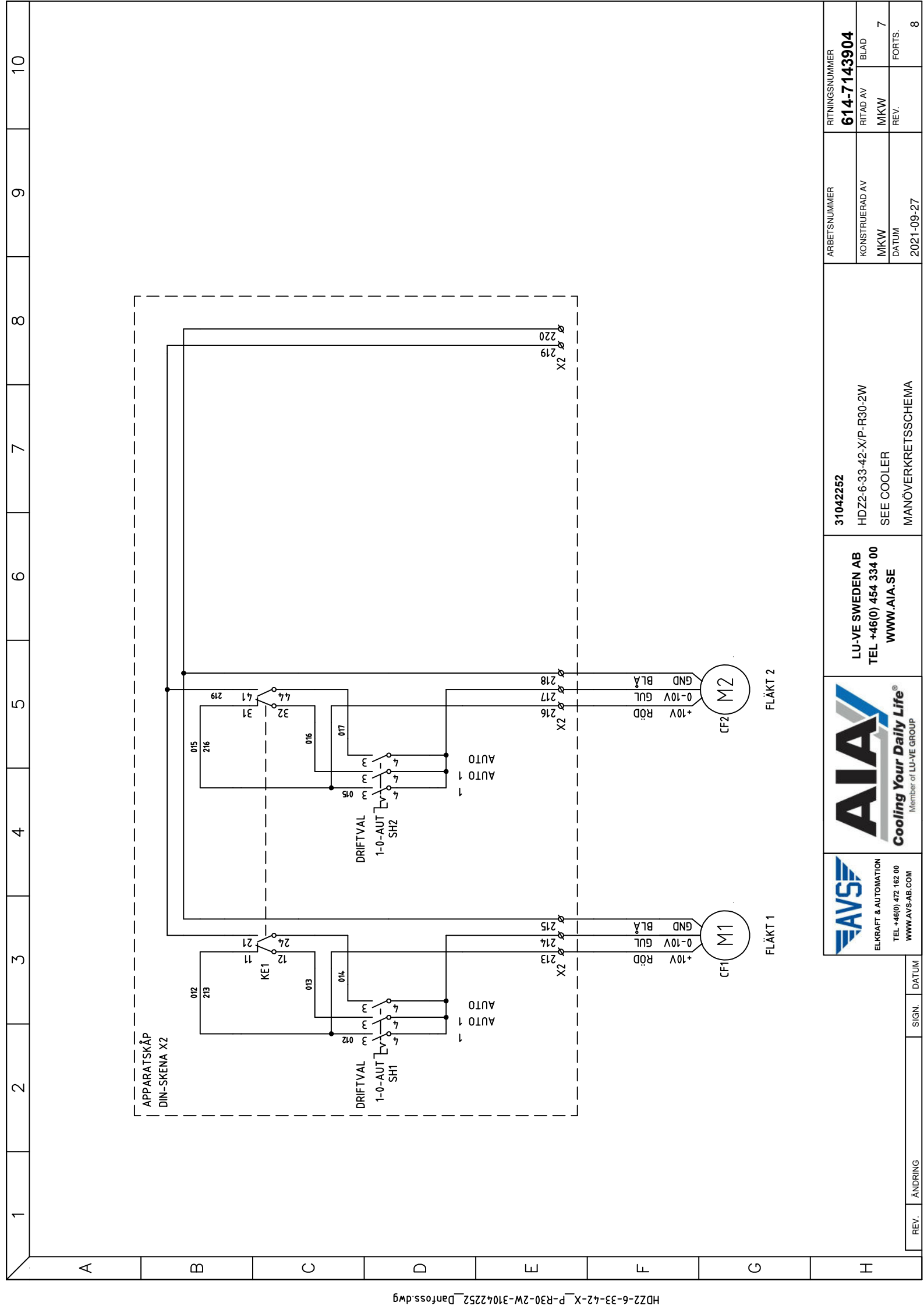

APPARATSKÅP
DIN-SKENA X2

DRIFTVAL
1-0-AUT SH1

DRIFTVAL
1-0-AUT SH2

CF1 M1

FLÄKT 1

CF2 M2

FLÄKT 2

AVS
ELKRAFT & AUTOMATION
TEL +46(0) 472 162 00
WWW.AVS-AB.COM

AIA
Cooling Your Daily Life®
Member of LU-VE GROUP

LU-VE SWEDEN AB
TEL +46(0) 454 334 00
WWW.AIA.SE

31042252
HDZ2-6-33-42-X/P-R30-2W
SEE COOLER
MÅNÖVERKRETSSCHEMA

ARBETSNUMMER	RITINGSNUMMER
KONSTRUERAD AV	614-7143904
MKW	BLAD
DATUM	REV.
2021-09-27	MKW
	7
	FORTS.
	8

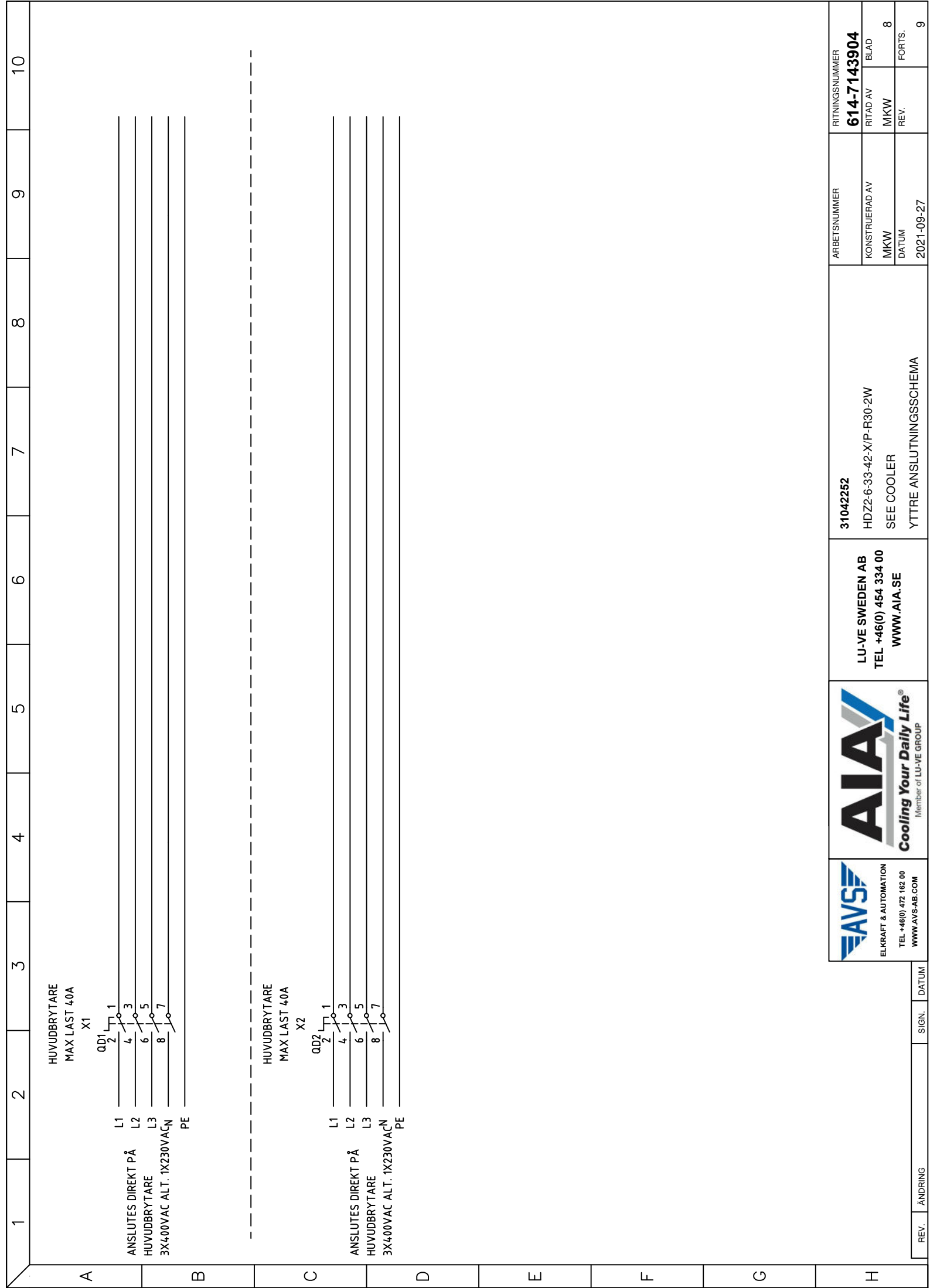

HUVUDBRYTARE
MAX LAST 40A

X1

QD1



L1
L2
L3
3X400VAC ALT. 1X230VACN
PE

HUVUDBRYTARE
MAX LAST 40A

X2

QD2



L1
L2
L3
3X400VAC ALT. 1X230VACN
PE



ELKRAFT & AUTOMATION
TEL +46(0) 472 162 00
WWW.AVS-AB.COM



Cooling Your Daily Life®
Member of LU-VE GROUP

LU-VE SWEDEN AB
TEL +46(0) 454 334 00
WWW.AIA.SE

31042252
HDZ2-6-33-42-X/P-R30-2W
SEE COOLER
YTTRE ANSLUTNINGSSCHEMA

ARBETSNUMMER
KONSTRUERAD AV
DATUM

614-7143904
MKW
2021-09-27

RITINGSNUMMER
RITAD AV
REV.
BLAD
MKW
FORTS.

8
8
9

REV. ÄNDRING SIGN. DATUM

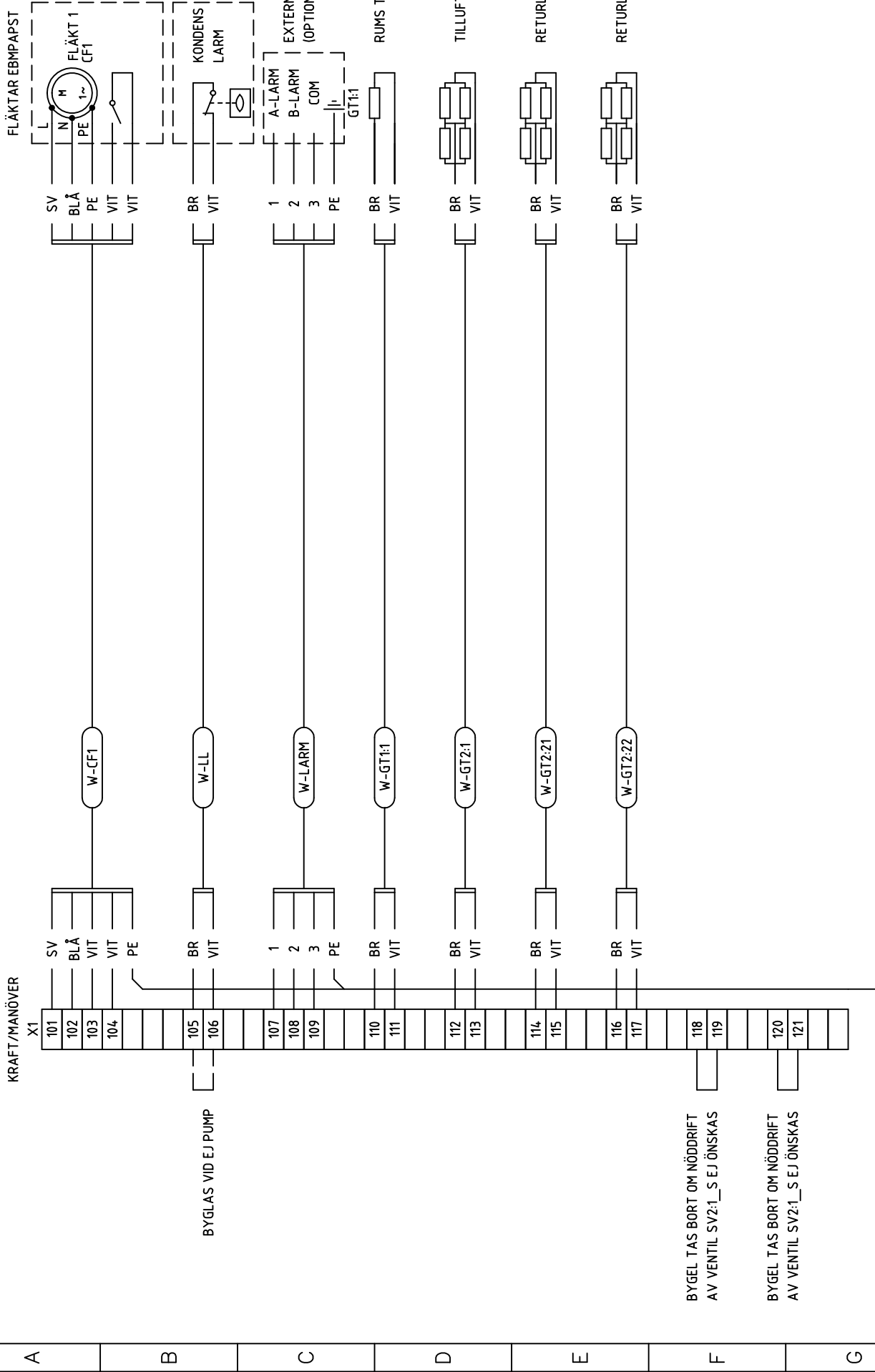



10
9
8
7
6
5
4
3
2
1

A B C D E F G H

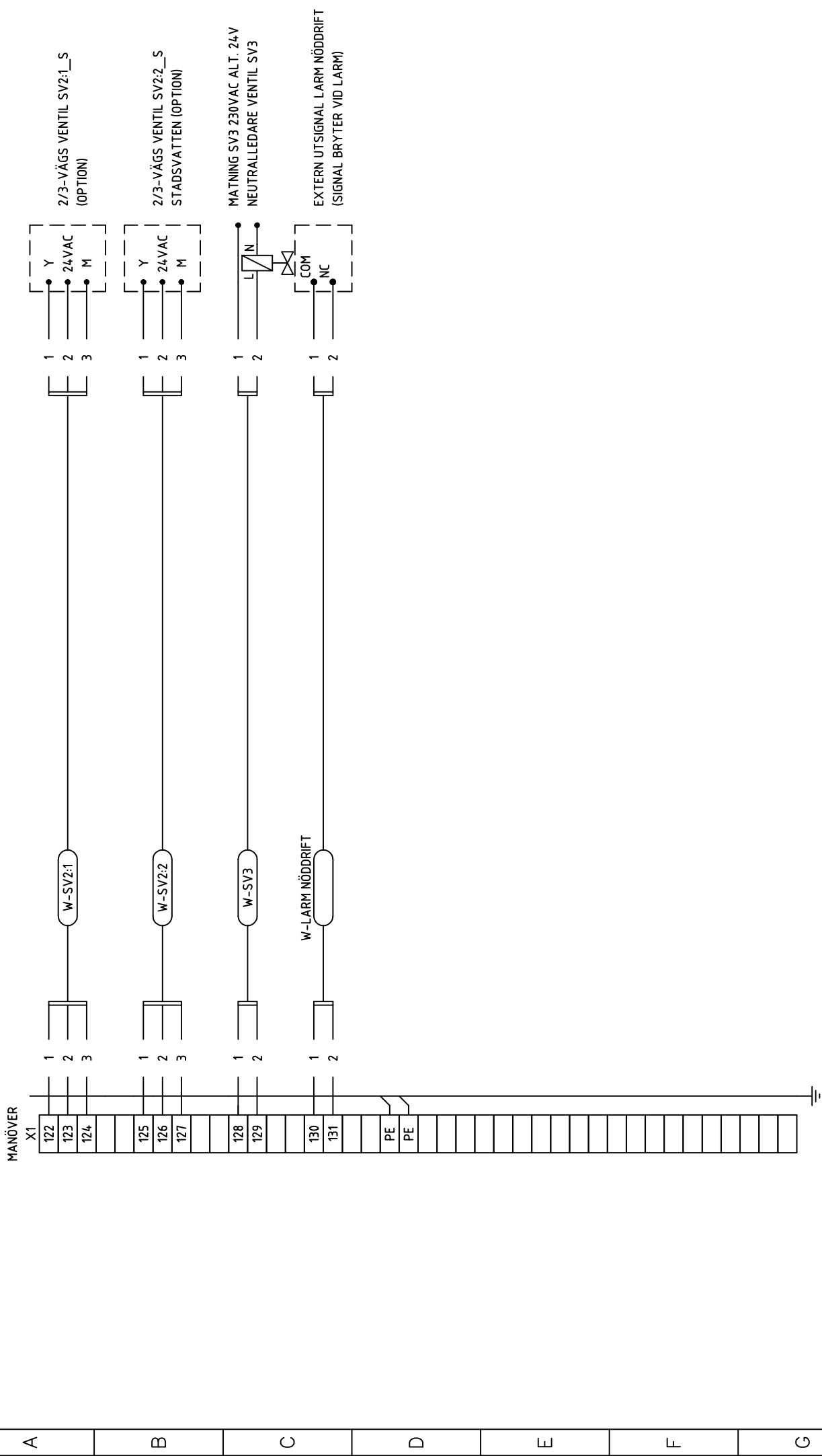
 ELKRAFT & AUTOMATION TEL +46(0) 472 162 00 WWW.AVS-AB.COM	 Cooling Your Daily Life® Member of LU-VE GROUP	LU-VE SWEDEN AB TEL +46(0) 454 334 00 WWW.AIA.SE	31042252 HDZ2-6-33-42-X/P-R30-2W SEE COOLER YTTRE ANSLUTNINGSSCHEMA	ARBETSNUMMER	RITTINGSNUMMER 614-7143904
				DATUM 2021-09-27	REV. MKW



1	2	3	4	5	6	7	8	9	10
---	---	---	---	---	---	---	---	---	----

 ELKRAFT & AUTOMATION TEL +46(0) 472 162 00 WWW.AVS-AB.COM	 Cooling Your Daily Life® Member of LU-VE GROUP	LU-VE SWEDEN AB TEL +46(0) 454 334 00 WWW.AIA.SE	31042252 HDZ2-6-33-42-X/P-R30-2W SEE COOLER YTTRE ANSLUTNINGSSCHEMA	ARBETSNUMMER	RITTINGSNUMMER
				KONSTRUERAD AV	RITAD AV
		MKW	MKW	REV.	REV.
		DATUM	DATUM		
					11
					10

KRAFT/MANÖVER

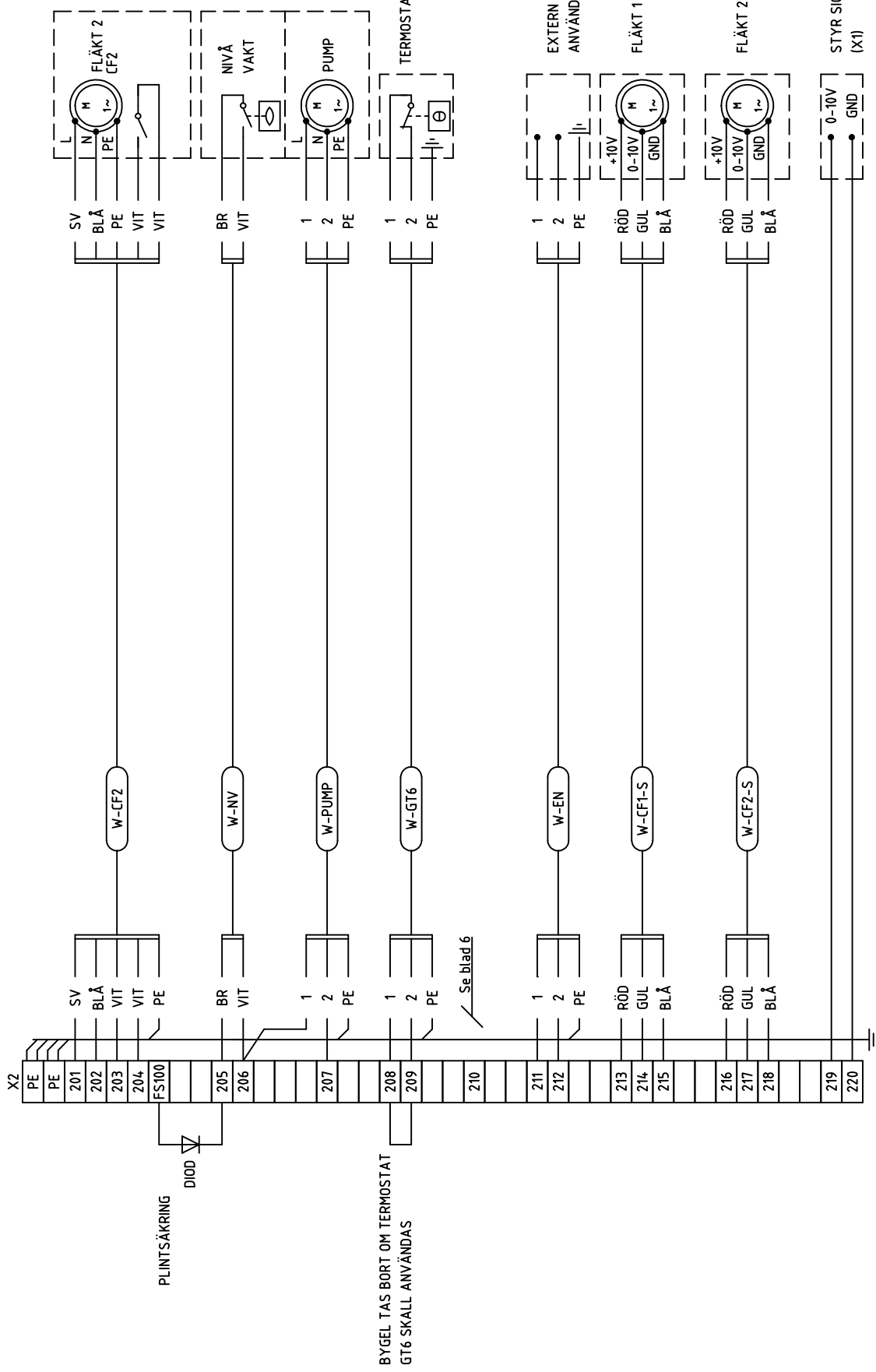

HD22-6-33-42-X1-P-R30-2W-31042252_Danfoss.dwg

AVS
ELKRAFT & AUTOMATION
TEL +46(0) 472 162 00
WWW.AVS-AB.COM

AIA
Cooling Your Daily Life®
Member of LU-VE GROUP

LU-VE SWEDEN AB
TEL +46(0) 454 334 00
WWW.AIA.SE

31042252
HD22-6-33-42-X1-P-R30-2W
SEE COOLER
YTTRE ANSLUTNINGSSCHEMA

ARBETSNUMMER	RITNINGSNUMMER
KONSTRUERAD AV	614-7143904
MKW	BLAD
DATUM	MKW 11
2021-09-27	REV.
	FORTS.
	/